

OSMO POCKET

User Manual

v1.0 2018.12

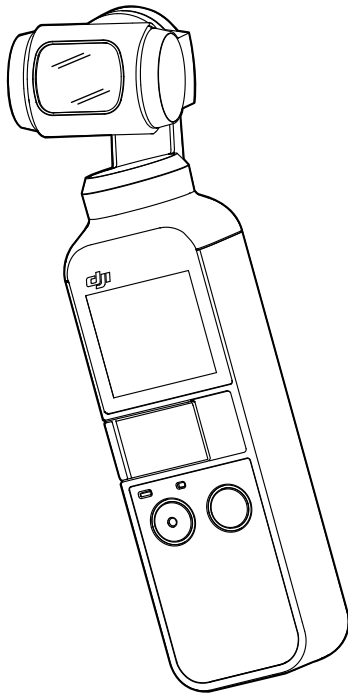

Searching for Keywords

Search for keywords such as “battery” and “install” to find a topic. If you are using Adobe Acrobat Reader to read this document, press Ctrl+F on Windows or Command+F on Mac to begin a search.

Navigating to a Topic

View a complete list of topics in the table of contents. Click on a topic to navigate to that section.

Printing this Document

This document supports high resolution printing.

Using this Manual

Legend

 Important

 Hints and Tips

Read Before First Use

Read the following documents before using OSMO POCKET™:

1. User Manual
2. Quick Start Guide
3. Disclaimer and Safety Guidelines

It is recommended to watch all tutorial videos on the official DJI™ website (www.dji.com/osmo-pocket) and read the Disclaimer and Safety Guidelines before first use. Prepare for first use by reviewing the Quick Start Guide and refer to this User Manual for more details.

Downloading the DJI Mimo App

Scan the QR code to the right or search for “DJI Mimo” on the App Store or Google Play.



The Android version of DJI Mimo is compatible with Android v5.0 and later. The iOS version of DJI Mimo is compatible with iOS v10.0 and later.

Contents

Using this Manual	2
Legend	2
Read Before First Use	2
Downloading the DJI Mimo App	2
Introduction	4
Overview	4
Activating Osmo Pocket	5
Charging Osmo Pocket	5
Operation	6
Button Feature	6
Adjusting the Gimbal Manually	6
Operating the Touch Screen	7
Storing Photos and Videos	9
Status LED Descriptions	9
DJI Mimo App	10
Updating Firmware	12
Maintenance	12
Specifications	13
After-Sales Information	14

Introduction

Osmo Pocket is a handheld gimbal camera that combines mobility and stability in one device. It shoots sharp 12 MP photos and stable video at up to 4K 60fps. The onboard touch screen displays a live view from the camera and can control camera and gimbal movements. Connect a mobile device to the DJI Mimo app where professional-quality videos can be created and shared to social media instantly in Story mode. Intelligent modes such as ActiveTrack, Panorama, and Timelapse give you everything you need for the perfect shot.

Accessories such as the Wireless Module and Controller Wheel can be used to enjoy more Osmo Pocket features.

Overview

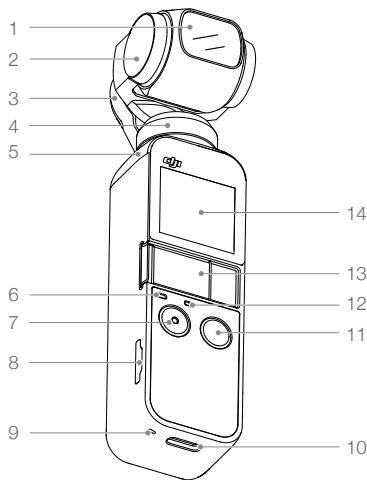

- | | |
|--------------------------|---------------------------|
| 1. Camera | 9. Microphone * |
| 2. Tilt Motor | 10. USB-C Port |
| 3. Roll Motor | 11. Power/Function Button |
| 4. Pan Motor | 12. Microphone * |
| 5. Ventilation Area | 13. Universal Port |
| 6. Status LED | 14. Touch Screen |
| 7. Shutter/Record Button | |
| 8. microSD Card Slot | |

* For better audio quality, DO NOT block the microphone when recording video.

Activating Osmo Pocket

When using Osmo Pocket for the first time, activation is required through DJI Mimo. Follow the steps below to activate.

1. Remove the cover on the universal port and choose a lightning or USB-C smartphone adapter to connect to Osmo Pocket.
2. Press and hold the Power/Function Button to power on.
3. Launch DJI Mimo and follow the on-screen instructions to activate Osmo Pocket.

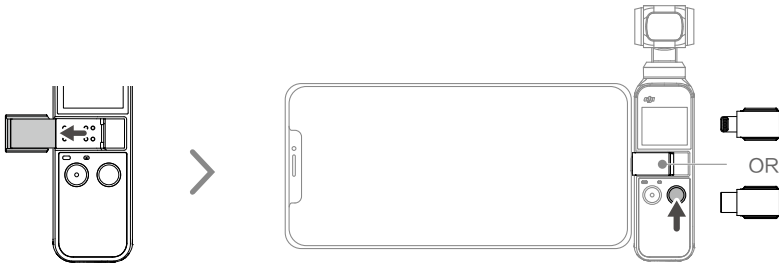

 DO NOT touch the gimbal when it is powering on. Otherwise, it may affect the performance.

Charging Osmo Pocket

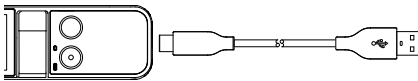

To charge Osmo Pocket, connect a USB adapter (not included) to the USB-C port using the provided power cable. The battery is fully charged when the status LED turns off.

The battery level is displayed on the touch screen after powering on Osmo Pocket.

Charging time: approx. 1 hour 13 minutes (when using a USB adapter of 5 V/2 A).

The status LED indicates the battery level during charging. Refer to the table below for details.

Blinking Pattern	Battery Level
Blinks green	0-24%
Blinks green twice	25%-49%
Blinks green three times	50%-74%
Blinks green four times	75%-99%
Glows solid green for six seconds and turns off	100%



- It is recommended to use a USB adapter of 5 V/2 A USB for optimal charging.
 - Make sure to charge Osmo Pocket in an environment where the temperature is within 41°-140° F (5°-60° C). For safety, Osmo Pocket limits the charge current when its temperature is between 113°-140° F (45°-60° C). In that case, Osmo Pocket cannot be fully charged.
-

Operation

Button Feature

Power/Function Button

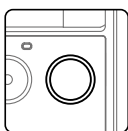

Press and hold the Power/Function button for one second to power on/off.

In camera view, press the Power/Function button once to switch between Video and Photo mode (not available when using Pro settings on DJI Mimo). Press the button twice to recenter the gimbal and press the button three times to switch the camera between facing forward and backward (requires firmware version v1.2.0.20 or higher).

In the touch screen settings page, press the button once to go back to the previous menu.

Shutter/Record Button

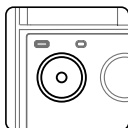

Press the Shutter/Record button once to take a photo or to start or stop recording a video in camera view. In the touch screen settings page, press once to go back to camera view.

Adjusting the Gimbal Manually

The tilt angle of Osmo Pocket can be adjusted manually. In Motionlapse, the pan angle can also be adjusted manually.

Operating the Touch Screen

The touch screen displays the camera view after Osmo Pocket is powered on, as well as the shooting mode, battery level, and microSD card information.

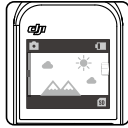





Swipe Down

Swipe down on the touch screen to enter the settings page. Swipe left or right to select between Glamour Effects, Superfine, and Save Settings (according to the shooting mode), System Settings, Screen Settings, and Brightness. Tap the icon to select a setting.

1. Glamour Effects: only available in Photo mode. Tap the icon to turn Glamour Effects on and off. Turn on Glamour Effects to beautify your photos.
 - Superfine: only available in Video mode. Tap the icon to turn Superfine on and off. Turn on Superfine to record higher quality video when recording in 1080 24/25/30p and 4K 24/25p. Note: shooting video with Superfine turned on may cause the device to generate excessive heat.
 - Save Settings: only available in Timelapse and Motionlapse modes. Choose to save only the converted video or the converted video and original images.
2. System Settings
 - Swipe left or right to scroll through settings.
 - Battery: displays the battery level of Osmo Pocket.
 - Calibration: tap the icon to calibrate the gimbal. Calibration is used to reduce drift caused by human error or nearby magnetic interference. Place Osmo Pocket on a steady flat surface and do not touch during calibration.
 - Tilt Control: tap to enable the virtual joystick for tilt axis control on the touch screen.
 - Auto Power Off: tap to set the auto power off timer.
 - Storage: displays the remaining capacity of the microSD card. Tap to enter and tap again to format the microSD card.
 - Accessories: displays information of connected Osmo Pocket accessories.
 - Anti-Flicker: prevent the flickering of lights by selecting the frequency according to local regulations.
 - More: view device information and firmware version, change language, and reset to default settings.
3. Screen Settings
 - Tap the icon to switch between the full screen display and letterbox display.
4. Brightness
 - Tap the icon to switch between the three brightness levels.





Swipe Up

Swipe up on the touch screen to enter the gimbal settings page.

1.  Re-center
Tap to re-center the gimbal.
2.  Flip
Tap to switch the camera between facing forward and backward.
3.  Follow
Tap to switch between Slow Follow and Fast Follow. In Slow Follow, the gimbal responds slower, but the movement is smoother. In Fast Follow, the gimbal responds faster, but more abruptly.
4.  Follow/Tilt Locked/FPV
Follow: pan and tilt axes follow.
Tilt Locked: only the pan axis follows.
FPV: pan, tilt, and roll axes follow.

Swipe Left

Swipe left on the screen to enter shooting mode setting page, and swipe up or down to select desired shooting mode.

1.  Photo
Swipe left to set the photo ratio and the countdown timer.
2.  Video
Swipe left to set the video resolution and frame rate.
3.  Slow Motion
Swipe left to set the speed.
4.  Timelapse
Swipe left and then up and down to choose between Timelapse and Motionlapse. Tap the blue icon in the camera view to set the duration and interval time. Once set, tap OK to confirm. To begin a Motionlapse, point the camera at the start point and tap the icon. Point the camera at the end point and tap the icon again.
5.  Panorama
Swipe left to switch between 180° and 3×3.

Swipe Right

Swipe up or down to scroll through photos and videos. Tap to playback videos. Swipe right to add favorites or delete photos and videos.

Double Tap

When in Photo, Video, or Slow Motion mode, double tap on the screen to enable ActiveTrack. FaceTrack is enabled if a face is detected. When the camera is facing toward the user, FaceTrack is enabled automatically. Press the Power/Function button or tap on the touch screen to exit ActiveTrack.



- ActiveTrack is disabled in FPV mode and Video mode with 4K 60fps resolution.
- When connected to DJI Mimo, the touch screen turns off and cannot be used.

Storing Photos and Videos

The footage shot on Osmo Pocket can be stored on a mobile device and a microSD card (not provided). If there is no microSD card inserted, only low bitrate video can be stored on a mobile device. Photo, Pano, and Timelapse will be unavailable. A UHS-I Speed Grade 3 rating microSD card is required due to the fast read and write speeds necessary for high-resolution video data.

Insert the microSD card into the microSD card slot as shown.

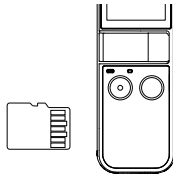

When there is a microSD card inserted in Osmo Pocket, photos and videos automatically store to the microSD card rather than the mobile device.

Status LED Descriptions

The status LED indicates different statuses on Osmo Pocket. Refer to the table below for details.

Blinking Pattern	Description
Blinks red three times quickly	Battery level is low and device is about to power off
Blinds red and green alternatively	Updating firmware
Solid red	Temperature is too high
Blinks red slowly	Recording video
Blinks yellow	No serial number
Solid yellow	Device not activated
Solid green	Working normally with microSD card inserted
Blinks green "X" times ("X" is the time of the countdown)	Interval countdown

DJI Mimo App

Home Page



Camera View: tap to enter camera view.

Home: tap to return to Home.

Edit: tap to edit footage from Osmo Pocket or import and edit footage from a mobile device.

Profile: register or log in to a DJI account. View works and settings, check likes and followers, send messages to other users, and connect with the DJI Store and Academy.

Camera View

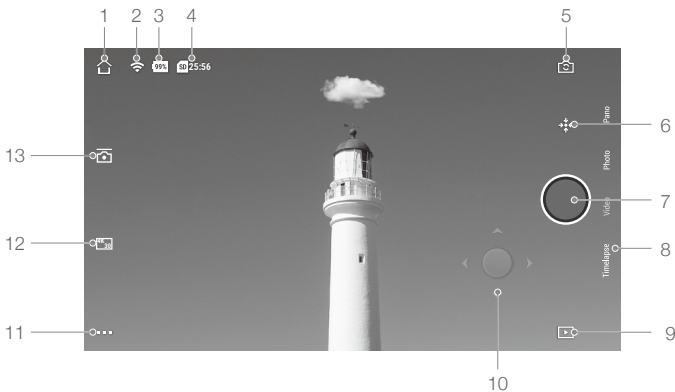

1. Home

: tap to return to home page.

2. Wi-Fi

: displays Wi-Fi connection with Wireless module.

3. Battery Level

: displays current battery level of Osmo Pocket.

4. microSD Card Information

 25:56 : displays either the remaining number of photos that can be taken or the duration of video that can be recorded according to the current shooting mode.

5. Flip

 : tap to switch the gimbal facing forward or backward.

6. Re-center

 : tap to re-center the gimbal.

7. Shutter Button

 : tap to take a photo or to start or stop recording video.

8. Shooting Mode

Scroll to select the shooting mode. Choose between Photo, Video, Slow Motion, Pano, Timelapse, Motionlapse (enabled in Timelapse settings), and Story (coming soon).

9. Playback

 : tap to preview photos and videos as soon as they are captured.

10. Virtual Joystick

 : pull the virtual joystick left and right to control pan axis movements, and pull the virtual joystick up and down to control tilt axis movements.

11. Settings

 : there are three setting pages.

Basic/Pro Settings

Choose different Basic and Pro settings for the selected shooting mode.

Shooting Mode	Basic Settings	Pro Settings
Timelapse	Timelapse original photo, Anti-flicker, Grid, Overexposed	Timelapse original photo, White balance, Anti-flicker, Grid, Overexposed, Histogram, Focus mode
Slow Motion	Anti-flicker, Grid, Overexposed	White balance, Color, Anti-flicker, Grid, Overexposed, Histogram, Focus mode
Video	Video format, Video quality, Anti-flicker, Grid, Overexposed	Video format, White balance, Anti-flicker, Volume amplification level, Noise reduction, Grid, Over exposed, Histogram, Focus mode
Photo	Photo ratio, Anti-flicker, Glamour effects, Grid, Overexposed	Photo format, Photo ratio, Anti-flicker, Glamour effects, Grid, Over exposed, Histogram, Focus mode
Pano	Anti-flicker, Grid, Overexposed	Photo format, White balance, Anti-flicker, Grid, Overexposed, Histogram, Focus mode
Story	Coming soon	Coming soon

Gimbal and Handle Settings

 : calibrate the gimbal and turn Gimbal Easy Control on and off. Turn on Gimbal Easy control to control tilt and pan axes with one virtual joystick. Turn off to control tilt and pan axes on two separate virtual joysticks.

General Settings

 : view the firmware version and SD card capacity and also format the SD card.

12. Camera Settings Shortcut

 : The camera settings shortcut is different according to the shooting mode.

13. Gimbal Settings

 : Select Slow Follow or Fast Follow and choose between Tilt Locked, Follow, and FPV mode.

Tap on the screen for focusing and metering. For ActiveTrack, drag a box on the screen and Osmo Pocket will track the subject. For FaceTrack, Osmo Pocket automatically detects faces and will track the subject.

Updating Firmware

Osmo Pocket's firmware must be updated through DJI Mimo. An on-screen alert will be received when new firmware is available. Follow the on-screen instructions to update the firmware.

-
-  • A microSD card is required to update firmware.
 - Make sure Osmo Pocket's battery level is at least 15% before updating firmware.
-

Maintenance

Place Osmo Pocket into the Cover as shown for safer transportation and storage.

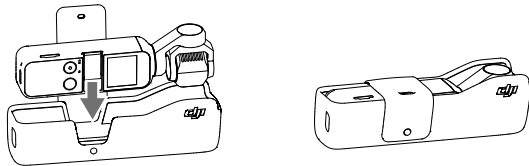

-
-  • Osmo Pocket contains delicate components that may be damaged upon impact, which may cause the gimbal to malfunction.
 - Make sure there is nothing obstructing the gimbal when Osmo Pocket is powered on.
 - Osmo Pocket is not water resistant. DO NOT use any liquid cleansers. Only use a soft dry cloth to clean Osmo Pocket.
 - Keep Osmo Pocket away from sand and dust to safeguard the sensors in the motors.
 - When Osmo Pocket is not in use, it is recommended to use the cover to protect the universal port. Avoid touching the universal port during use as it may become hot.
 - Do not cover or touch the ventilation area of Osmo Pocket as it may become hot during use. Osmo Pocket will stop shooting if it starts to overheat.
 - To prevent unnecessary gimbal damage, make sure to place Osmo Pocket into the Cover correctly.
 - Make sure to hold Osmo Pocket and your smartphone firmly when using the smartphone adapter to mount your smartphone to Osmo Pocket.
-

Specifications

General	
Name	Osmo Pocket
Model	OT110
Dimensions	121.9×36.9×28.6 mm
Weight	116 g
Input	5 V/2 A or 5 V/1 A
Output	5 V/500 mA
Gimbal	
Angle Vibration Range	±0.005°
Controllable Range	Pan: -230° to +50°, Roll: ±45°, Tilt: -95° to +50°
Mechanical Range	Pan: -250° to +70°, Roll: ±90°, Tilt: -120° to +98°
Max Controllable Speed	120°/s
Camera	
Sensor	1/2.3" CMOS, Effective pixels: 12M
Lens	FOV 80°, F2.0
ISO	Photo: 100 – 3200 Video: 100 – 3200
Electronic Shutter Speed	1/8000 – 8 s
Max Image Size	4000×3000
Still Photography Modes	Single Shot, Countdown, Pano
Video Resolution	4K Ultra HD: 3840×2160 24/25/30/48/50/60p FHD: 1920×1080 24/25/30/48/50/60p
Video Recording Modes	Timelapse/Slow Motion (video resolution is 1080 120p)/Normal
Max Video Bitrate	100Mbps
Supported File Formats	FAT32(≤32 GB) / exFAT (>32 GB)
Photo Formats	JPEG/JPEG+DNG
Video Formats	MOV/MP4 (MPEG-4 AVC/H.264)
Supported SD Cards	Max. 256 GB SDHC/SDXC UHS-I or UHS-3 microSD
Operating Temperature	0°-40° C (32°-104° F)
Audio Output	48 KHz, AAC
Battery	
Type	LiPo
Capacity	875 mAh
Energy	6.738 Wh

Voltage	7.7 V
Charging Voltage Limit	8.8 V
Charging Environment Temperature	41°-140° F (5°-60° C)
Operating Temperature	32°-104° F (0°-40° C)
Operating Time	140 mins (this value is tested in a laboratory environment when recording 1080 30fps video and should only be used for reference.)
Charging Time	73 mins (when using a USB adapter of 5 V/2 A)

After-Sales Information

Visit <https://www.dji.com/support> to learn more about after-sales service policies, repair services, and support.

DJI Support
<http://www.dji.com/support>

This content is subject to change.

Download the latest version from
www.dji.com/osmo-pocket

OSMO is a trademark of DJI.

Copyright © 2018 DJI OSMO All Rights Reserved.